

DE OPENBARE VERDEDIGING VAN HET PROEFSCHRIFT

The Developmental Origins of Children's Energy Balance-Related Behavior and Physical Fitness



AREND W. VAN DEUTEKOM

VRIJDAG 21 APRIL 2017

Achtergrond

*“De omgeving in je vroege ontwikkeling
beïnvloedt
je latere gezondheid en ziekte.”*

Achtergrond

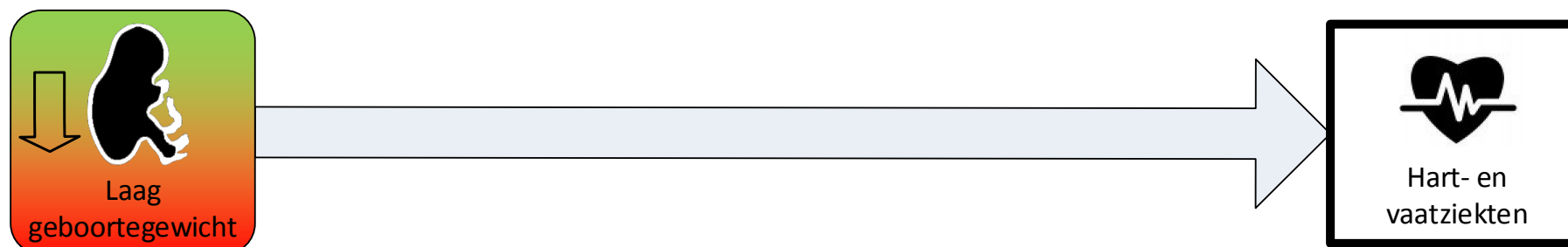

Achtergrond

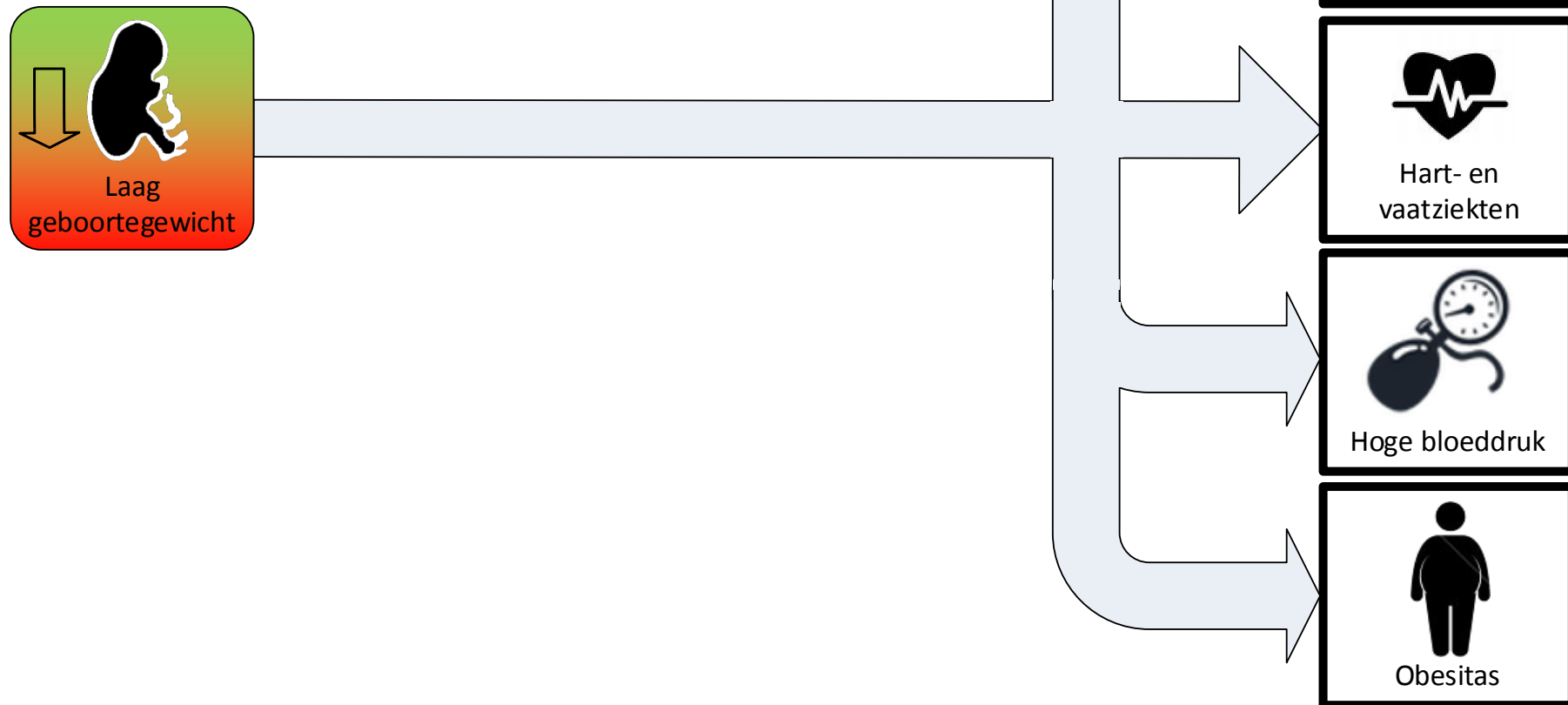

Achtergrond

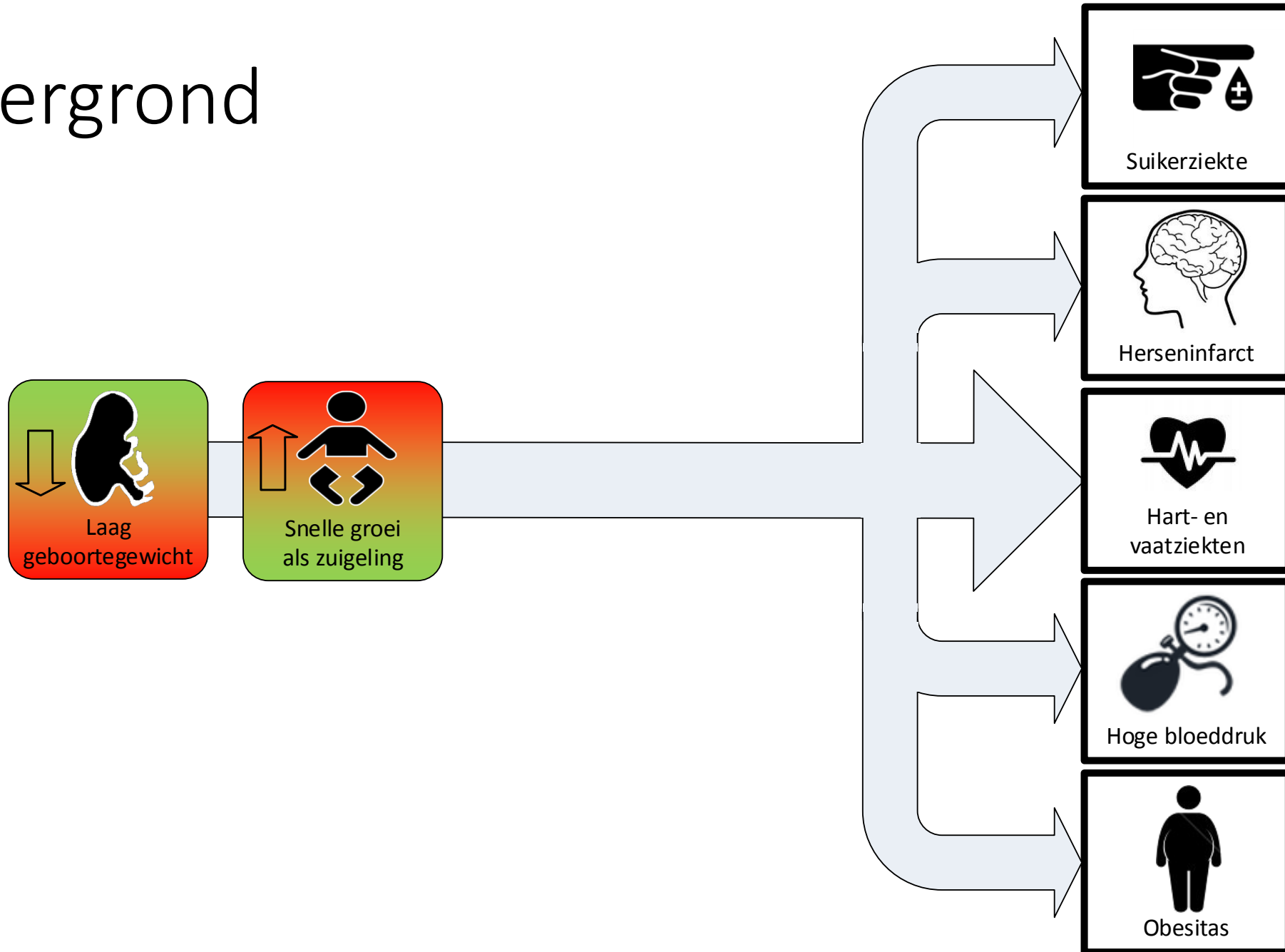

Achtergrond

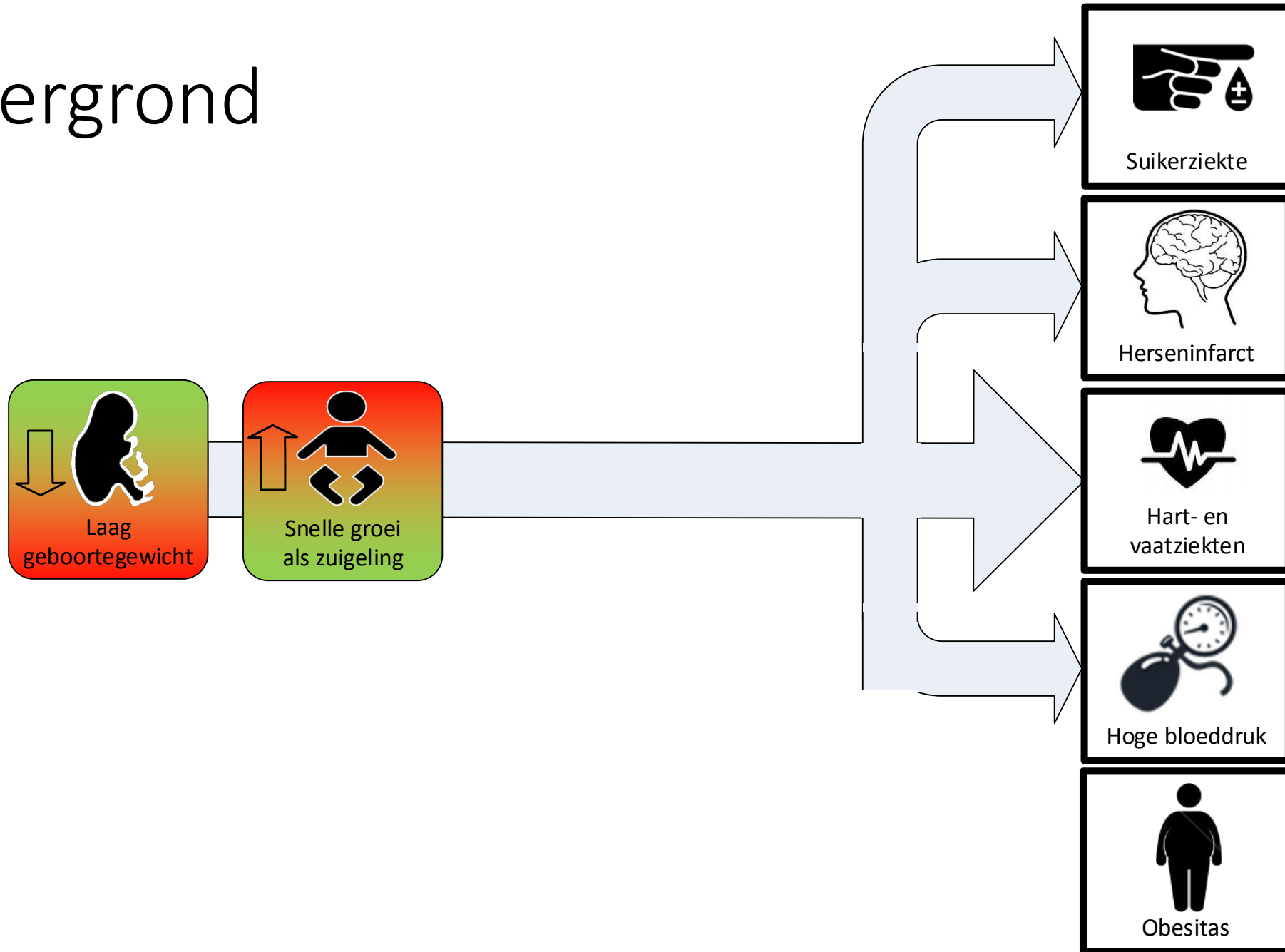

Achtergrond



Achtergrond

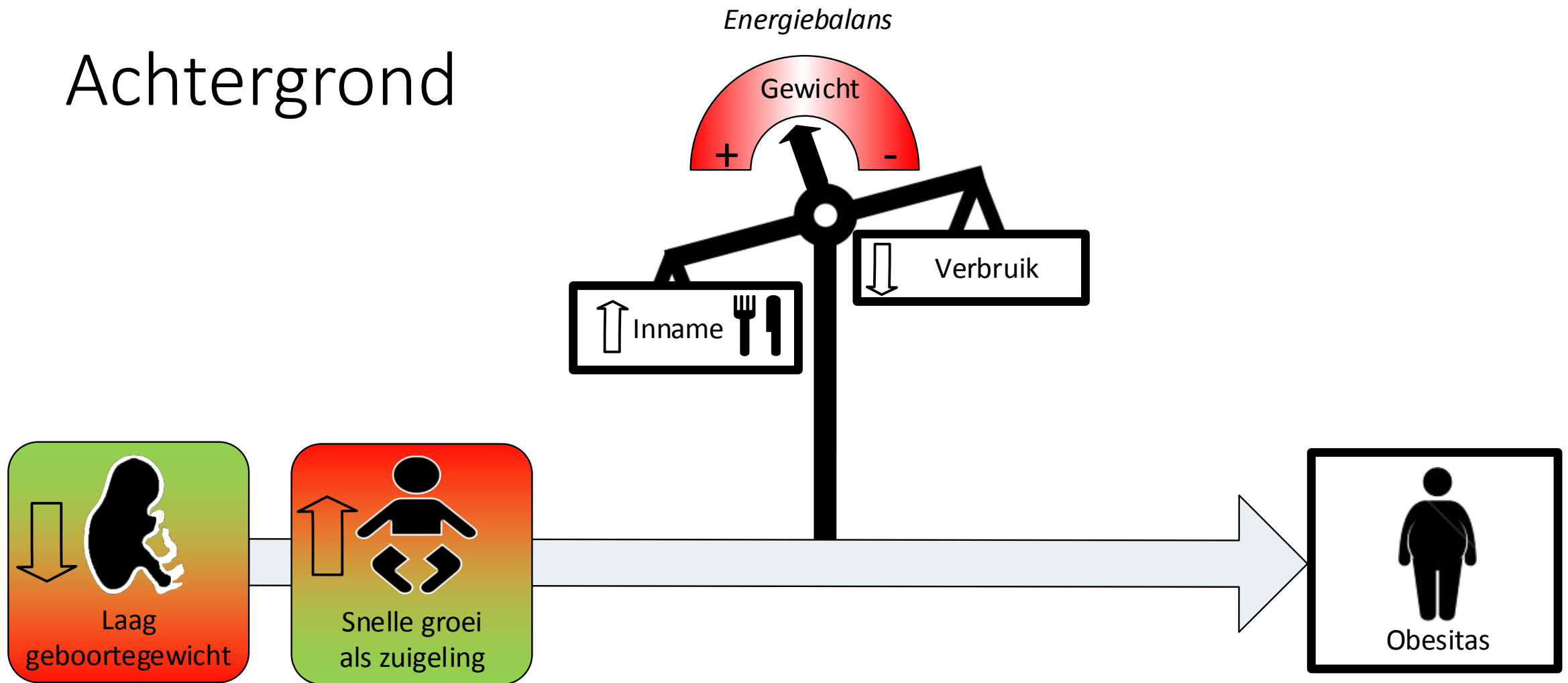

Achtergrond

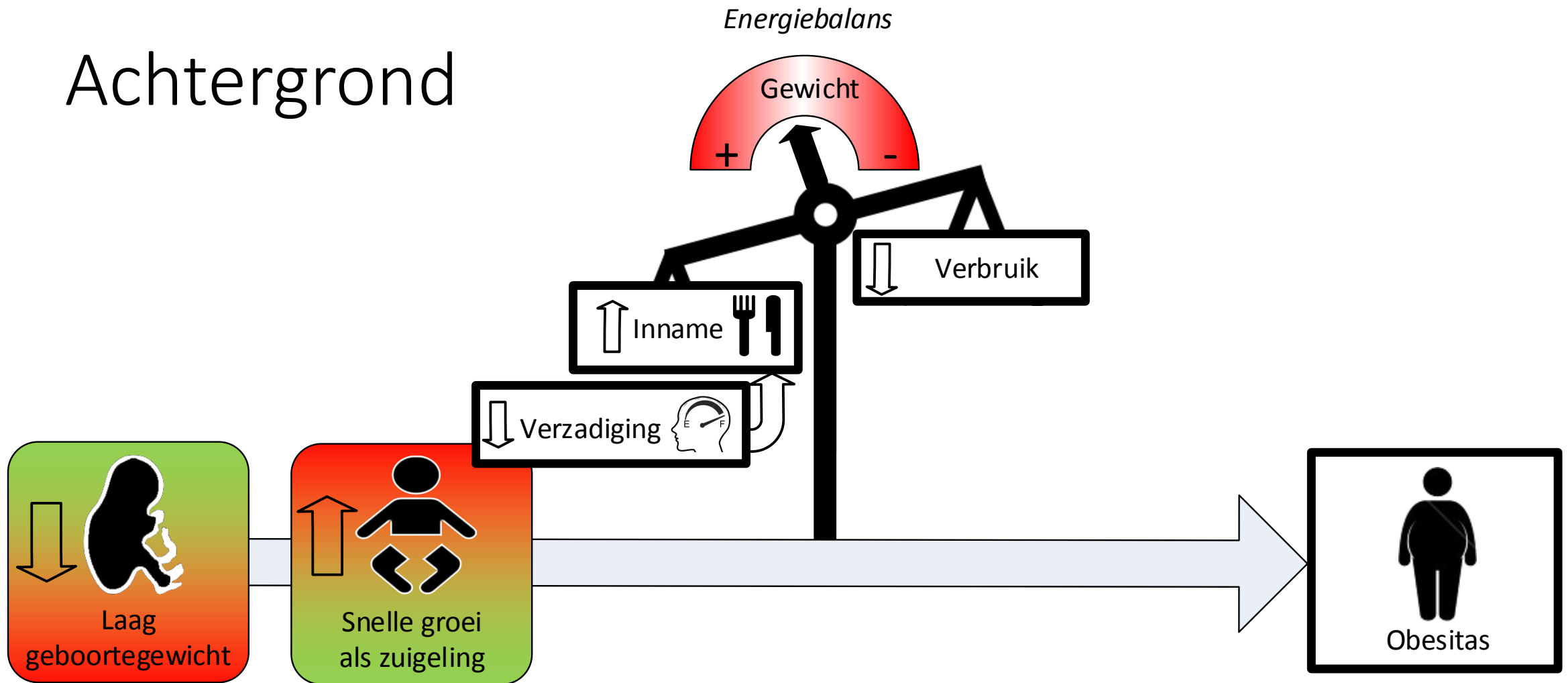

Achtergrond

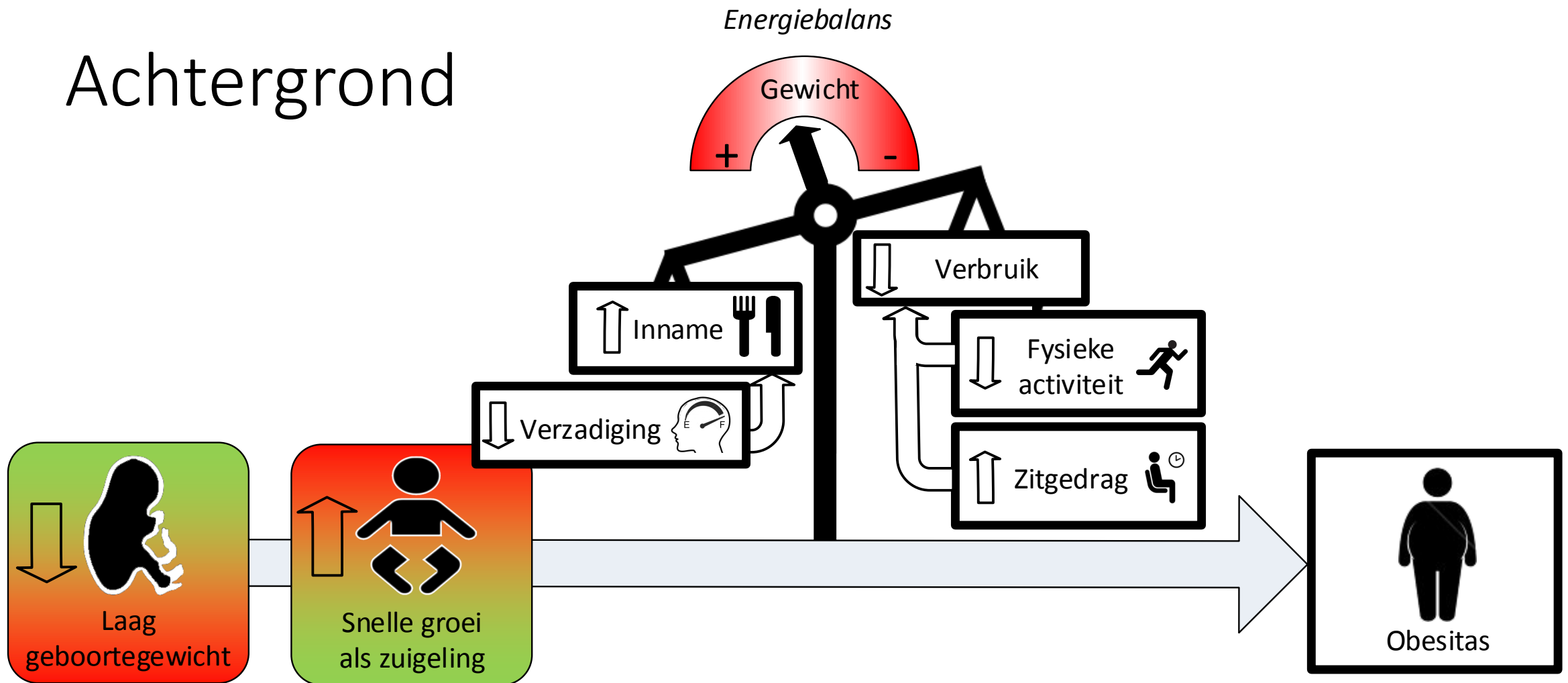

Achtergrond

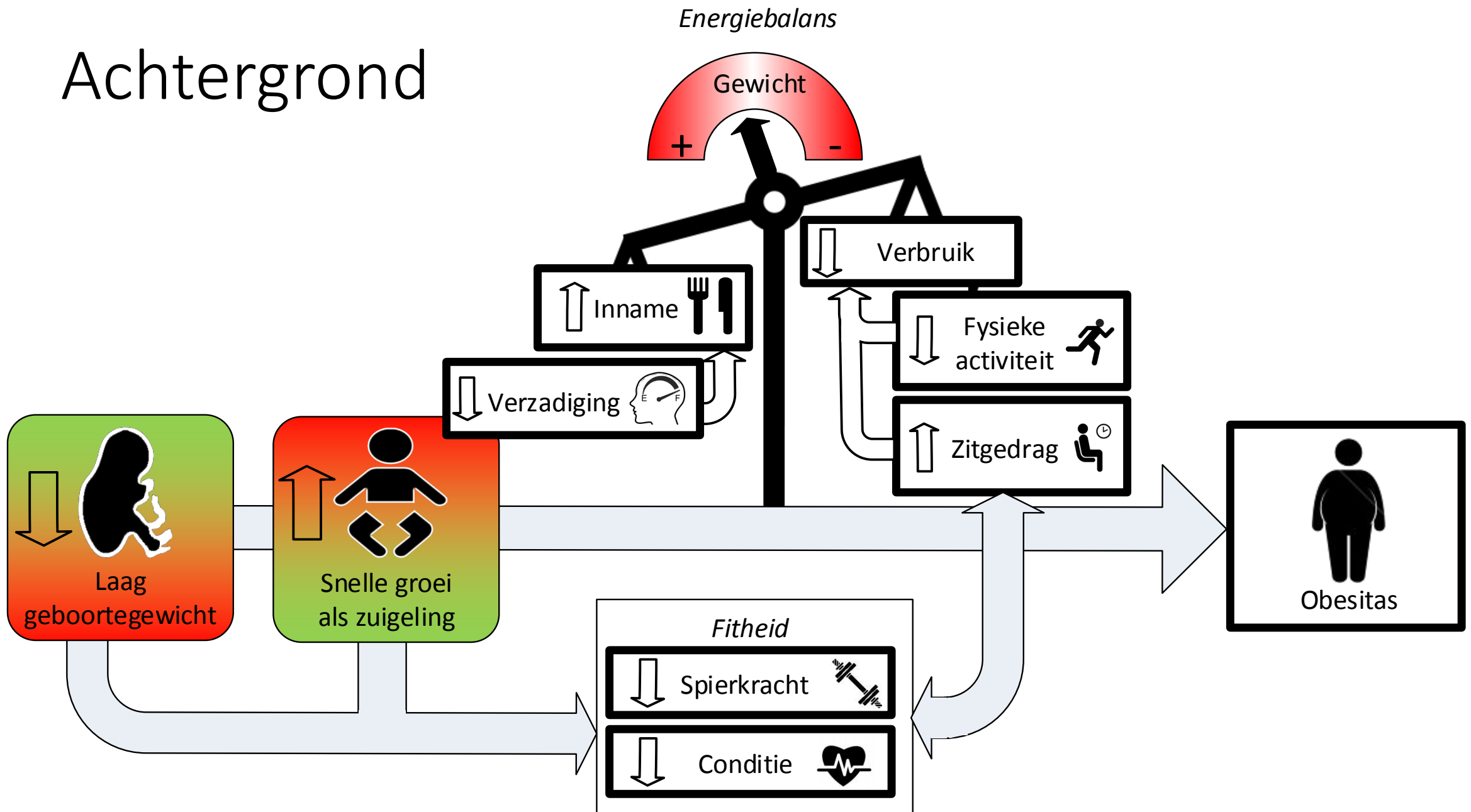

Achtergrond

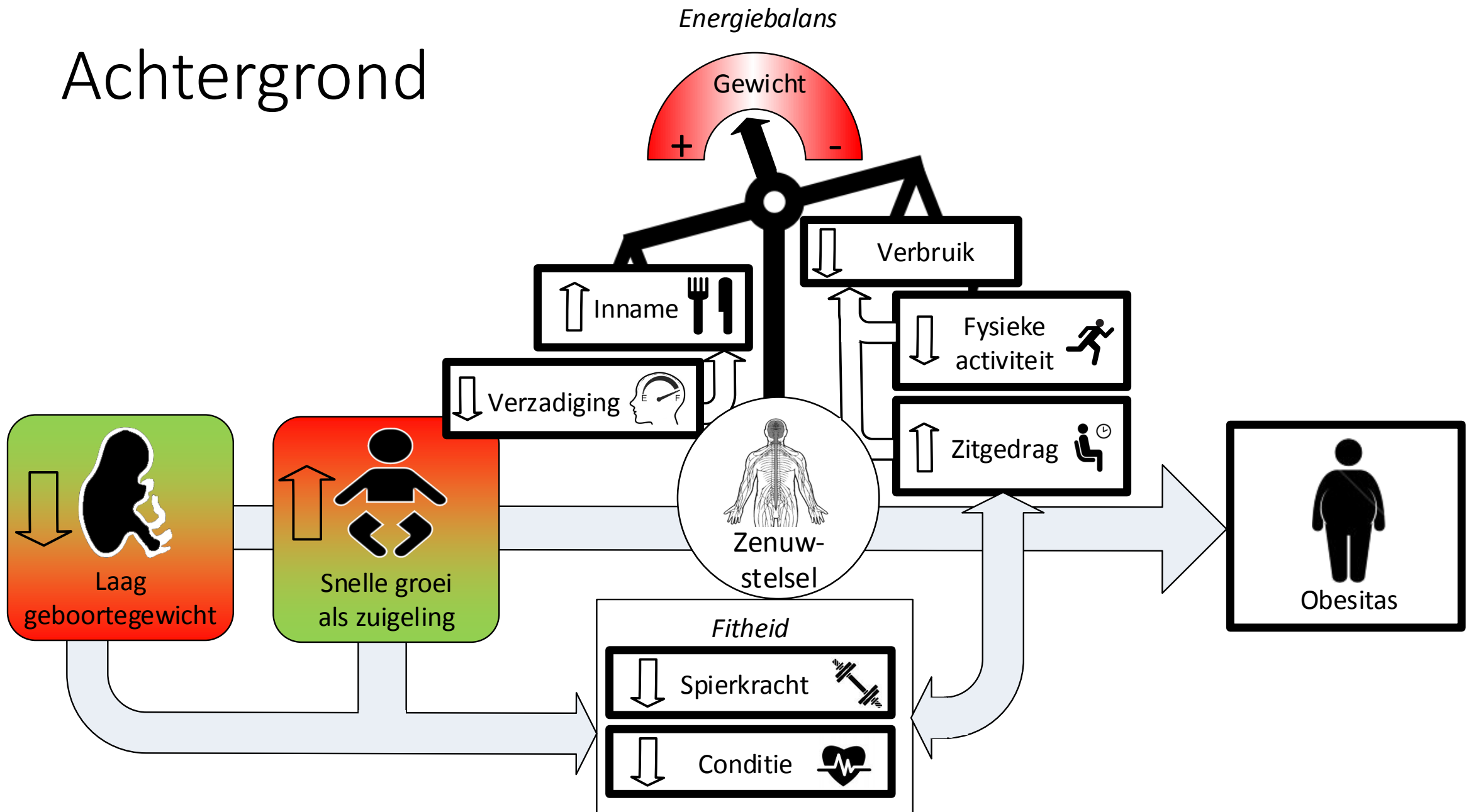

Achtergrond

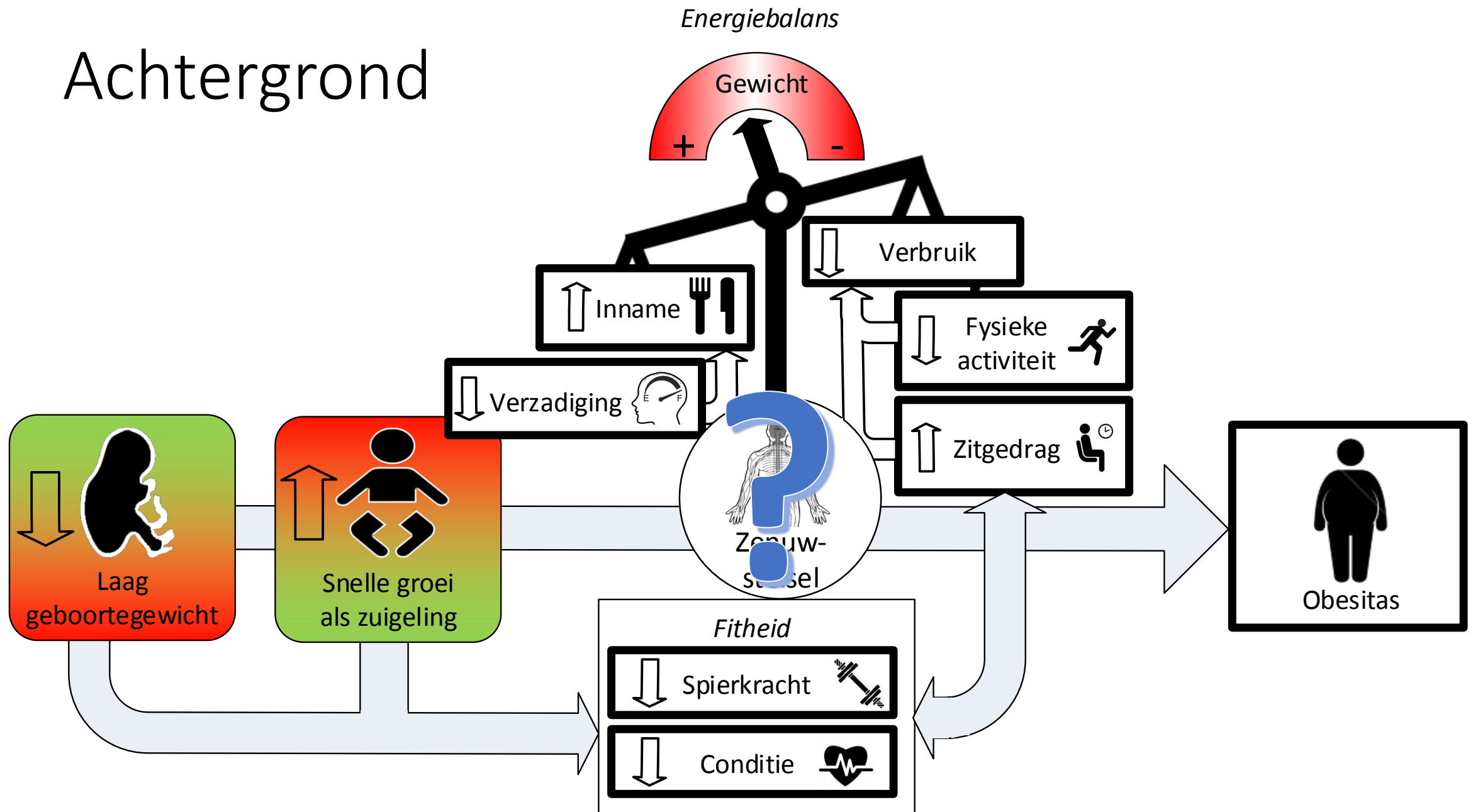

Onderzoeksvragen



Methoden

- 'Amsterdam Born Children and their Development' studie:



Methoden

- 'Amsterdam Born Children and their Development' studie:

2003: 8000 kinderen geboren;



Methoden

- 'Amsterdam Born Children and their Development' studie:

2003: 8000 kinderen geboren;



2008 (5 jaar): 3000 kinderen deden mee aan gezondheidsmeting;



Methoden



↓
2012 (8-9 jaar): 194 kinderen deden mee met fitheidstesten.

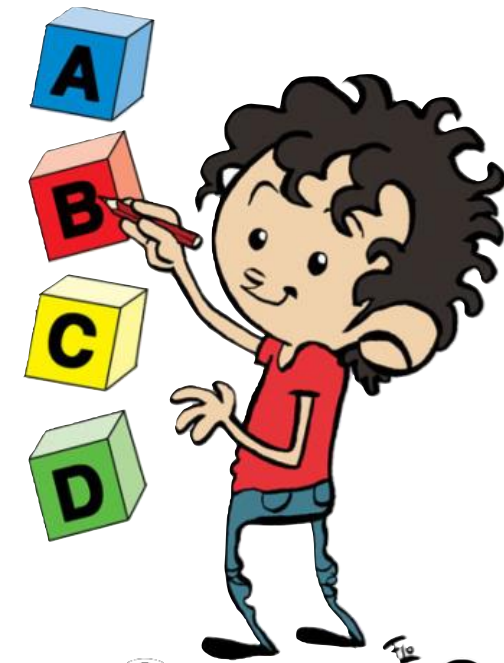

Geboortegewicht



Zuigelingsgroei



Energie inname



Verzadiging



Zenuwstelsel



Fysieke Activiteit



Zitgedrag



Spierkracht



Conditie

Resultaten

Resultaten

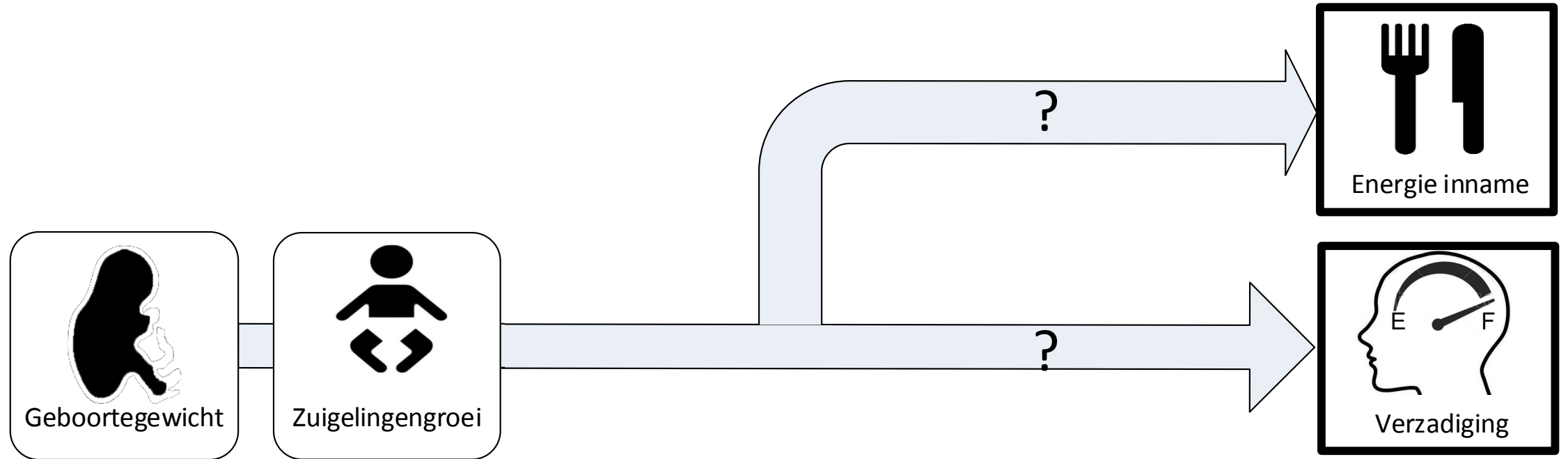

Resultaten

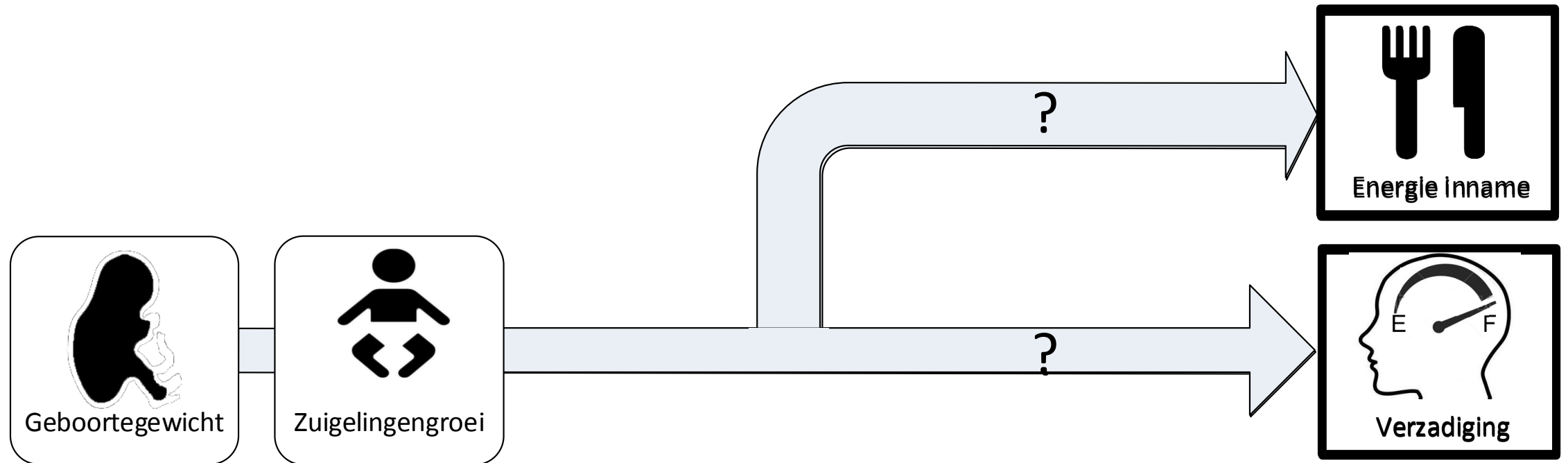

Resultaten

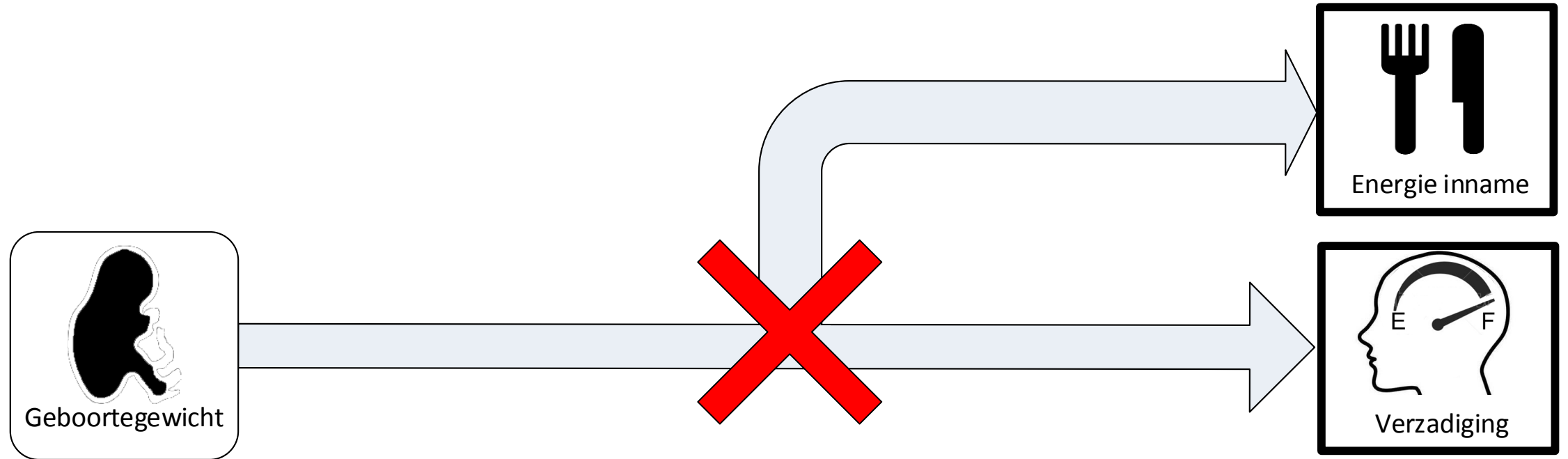

Resultaten

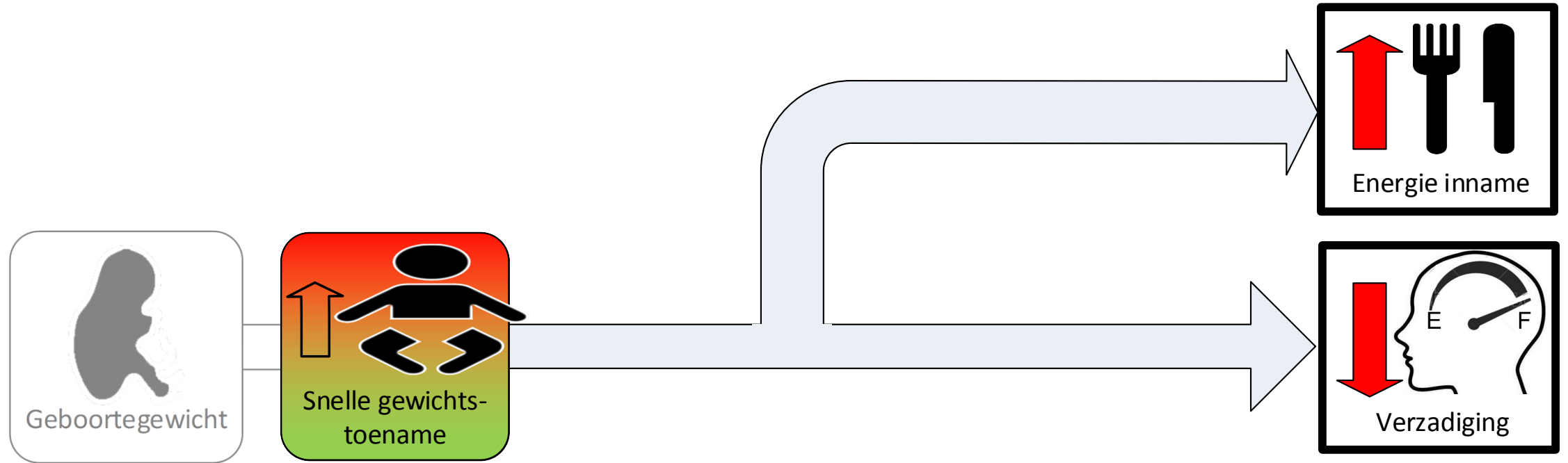

Resultaten

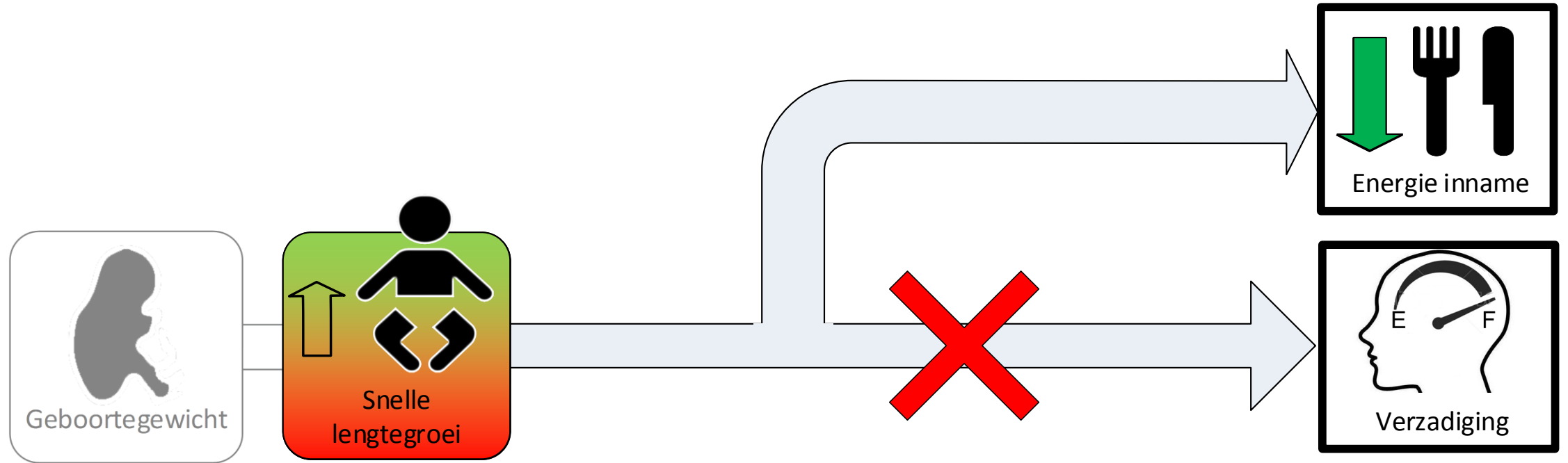

Resultaten

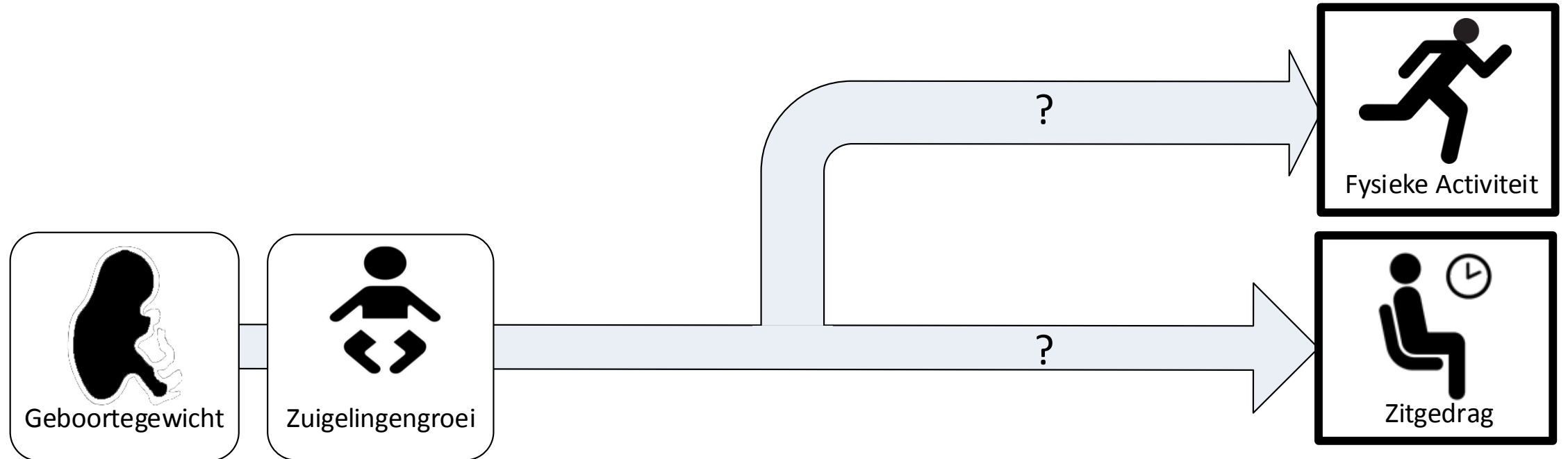

Resultaten

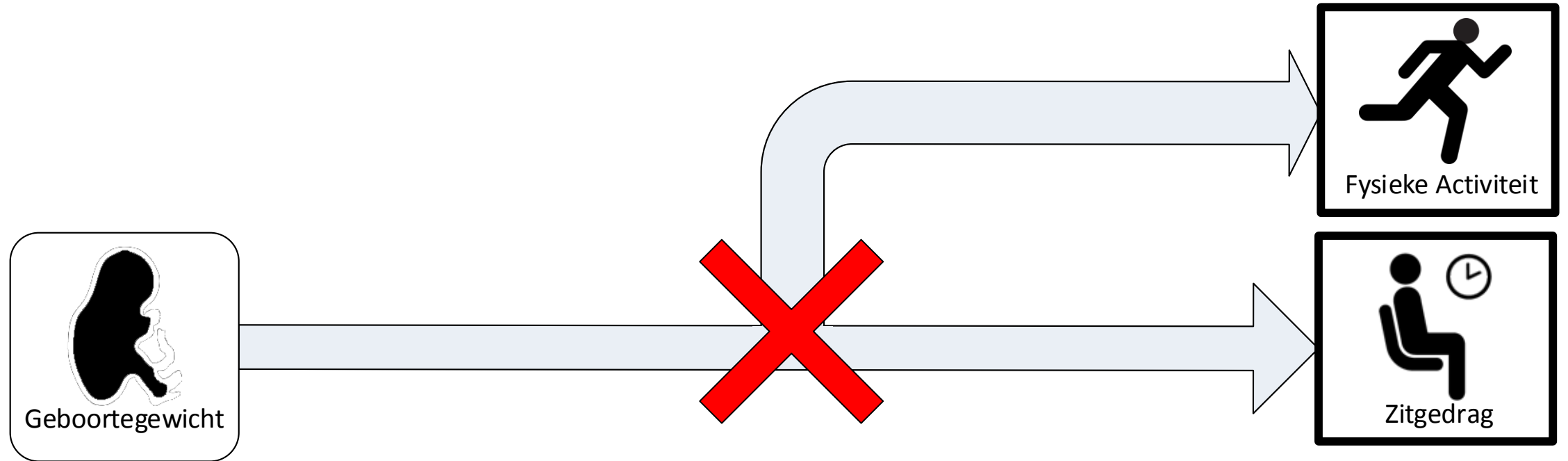

Resultaten

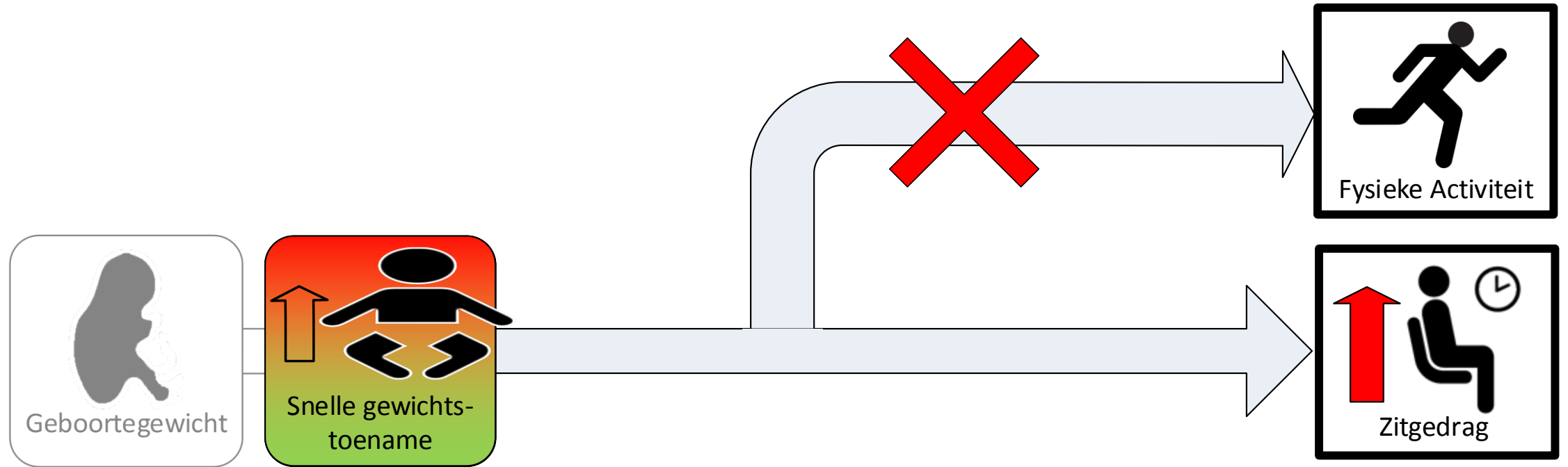

Resultaten

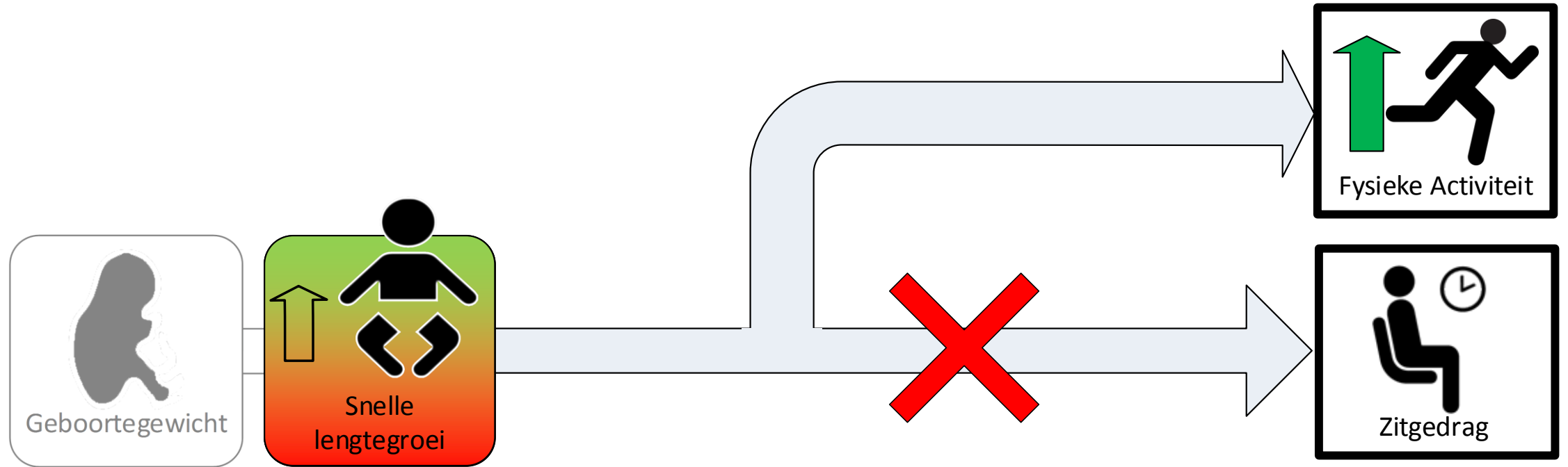

Resultaten

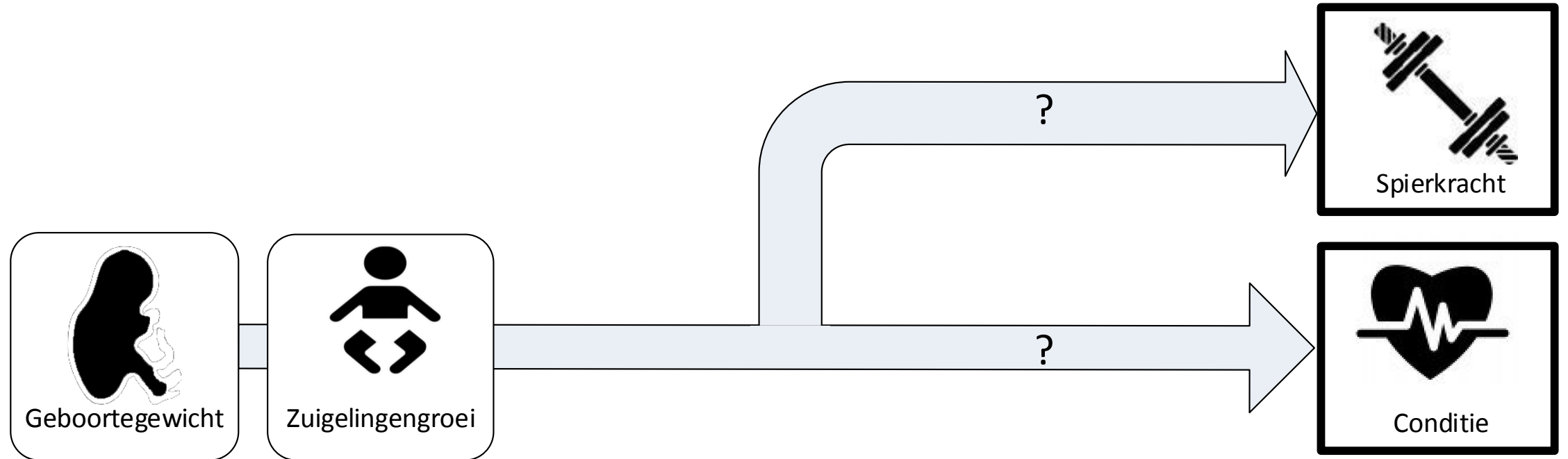

Resultaten

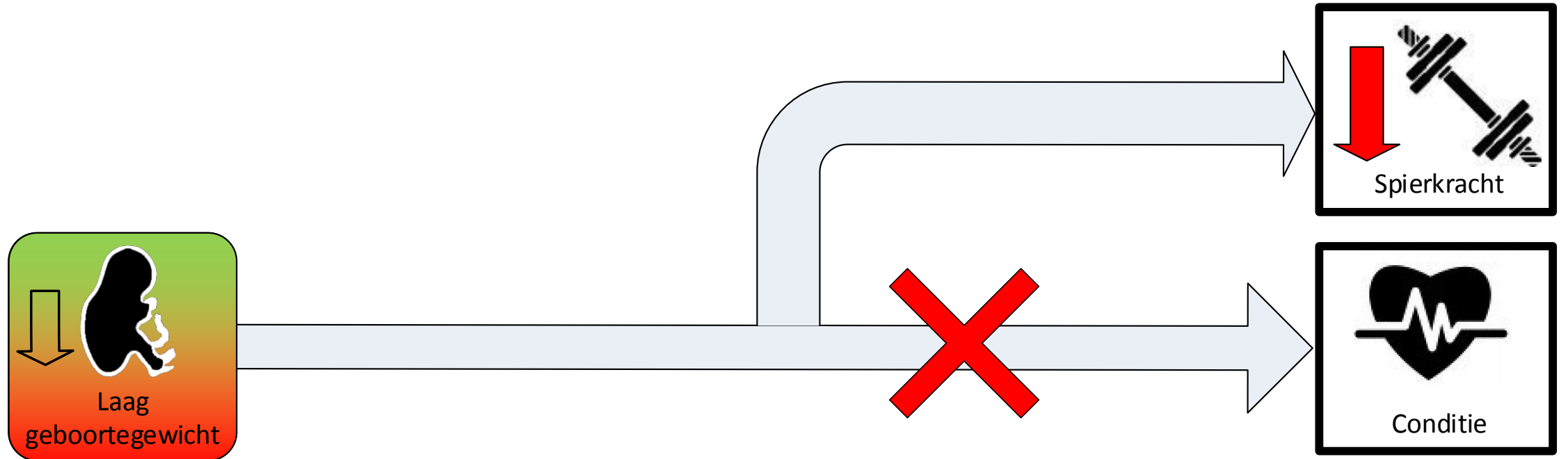

Resultaten

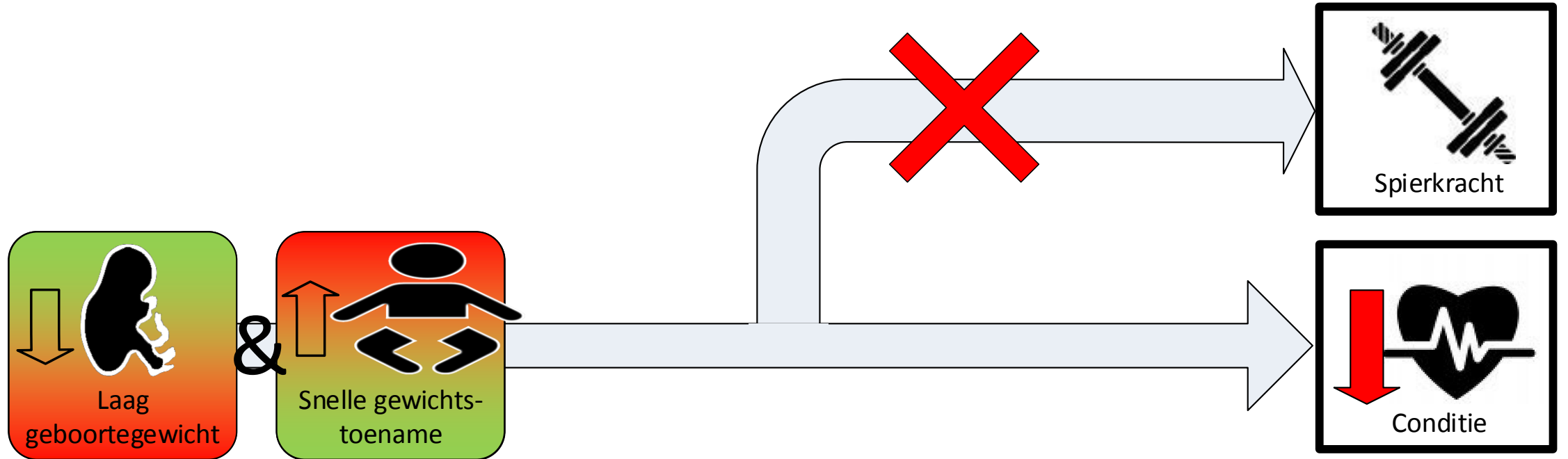

Resultaten

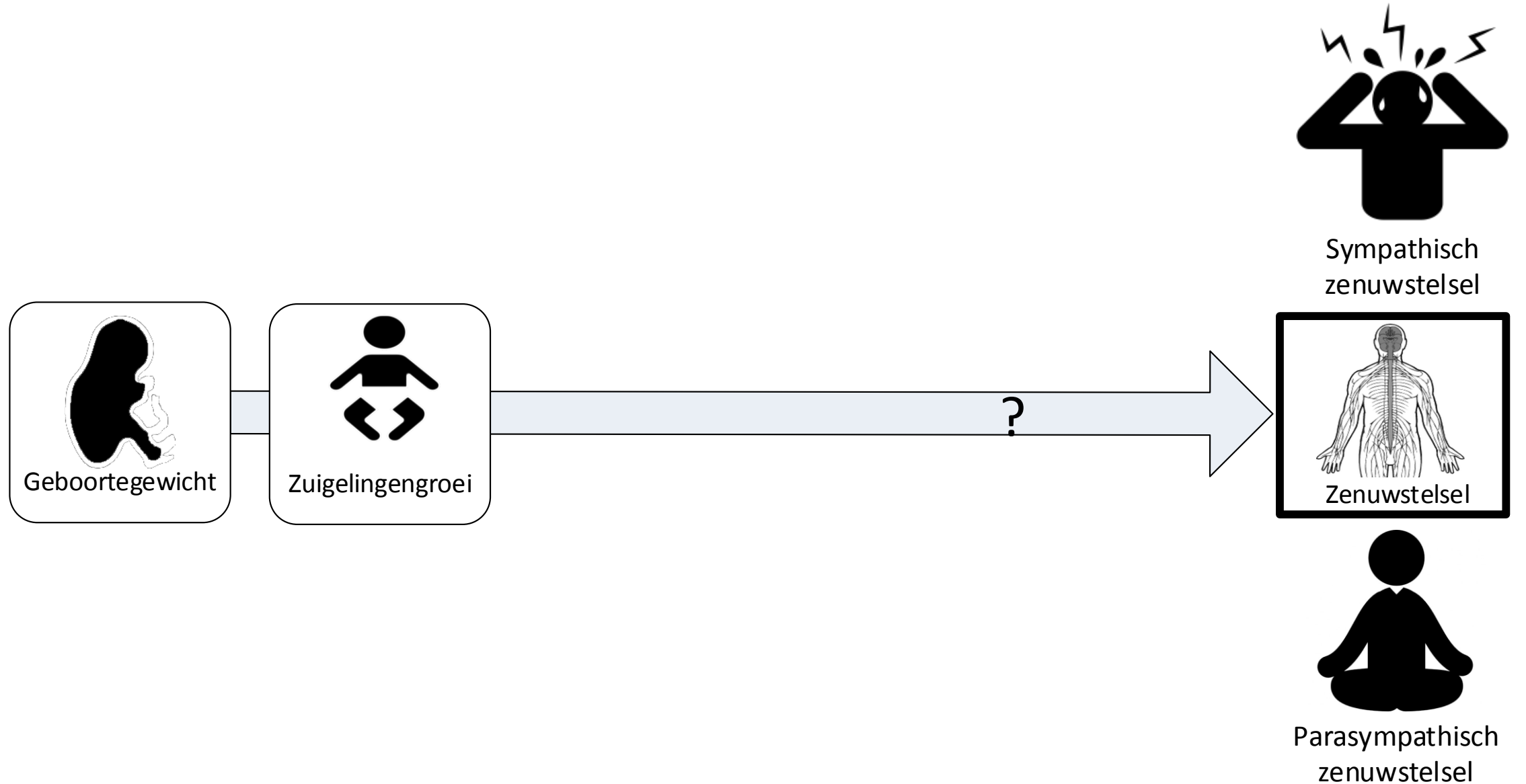

Resultaten

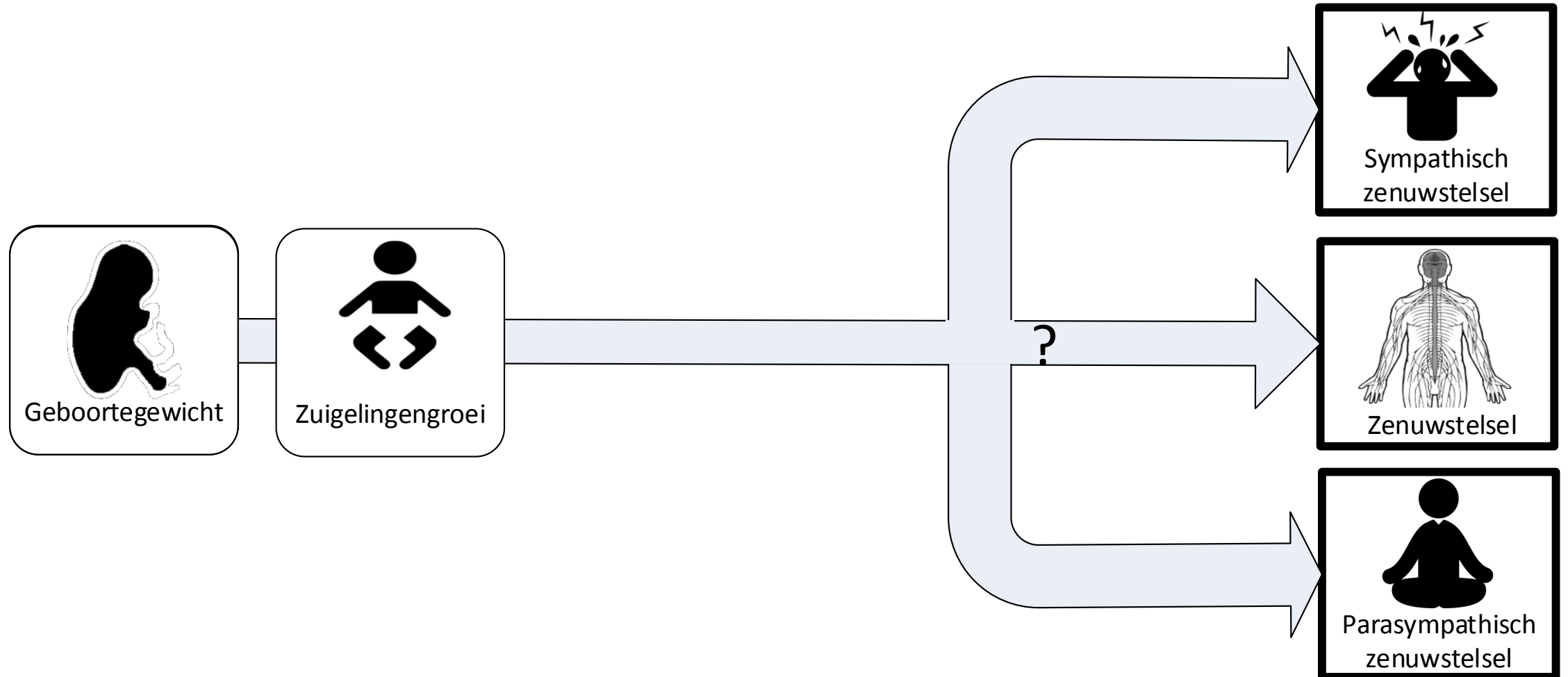

Resultaten

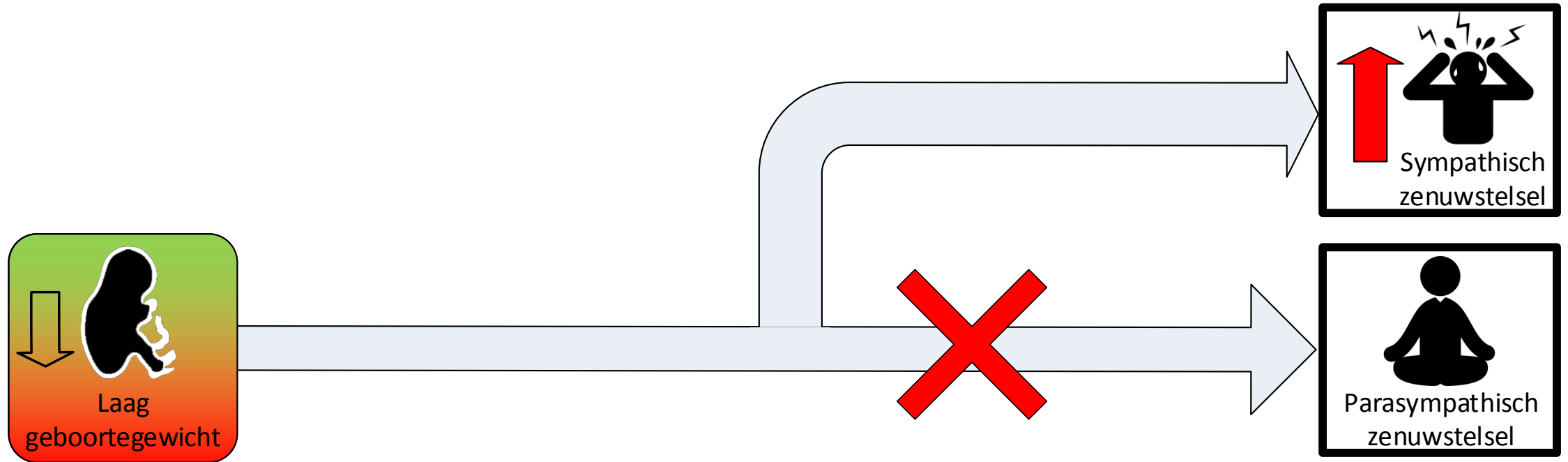

Resultaten

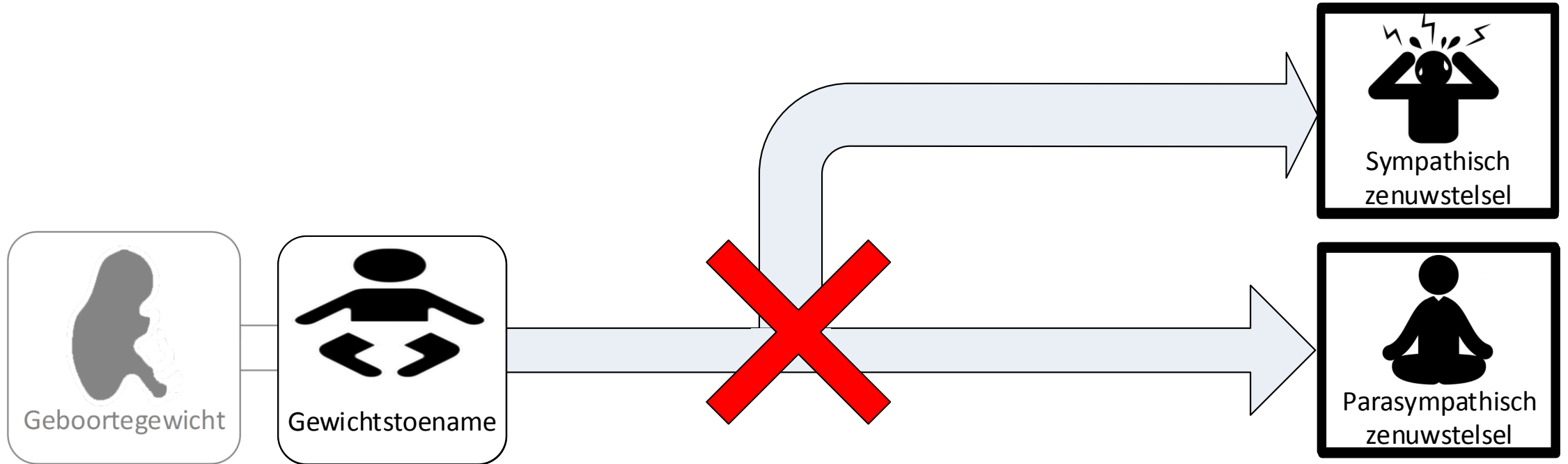

Resultaten

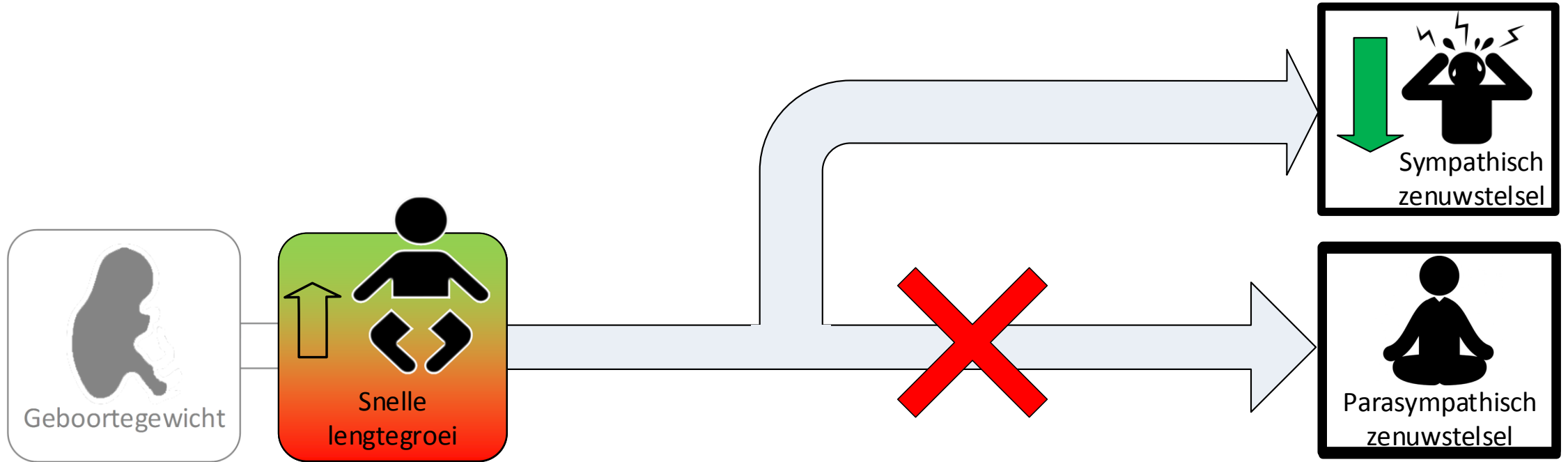

Resultaten

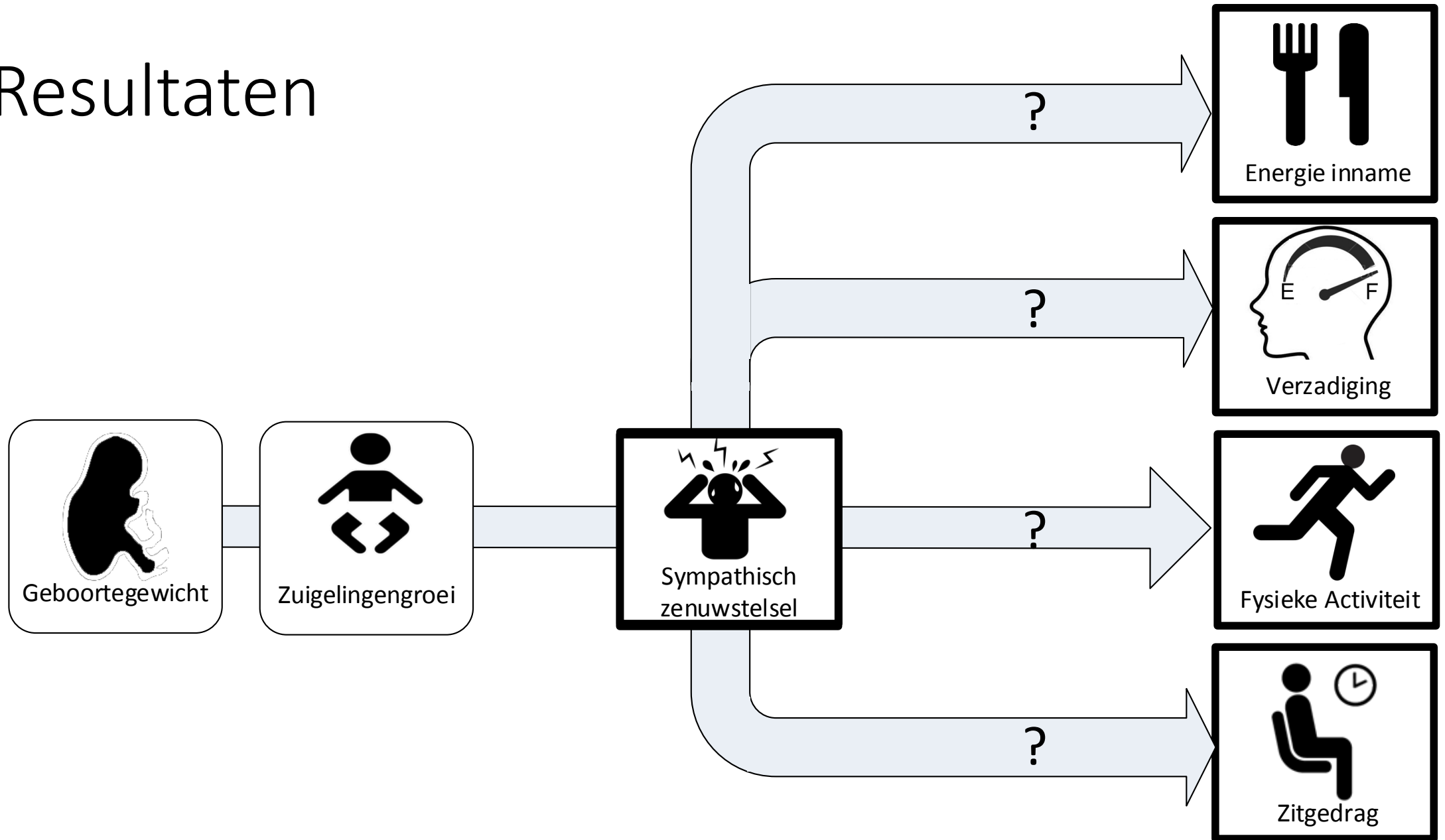

Resultaten

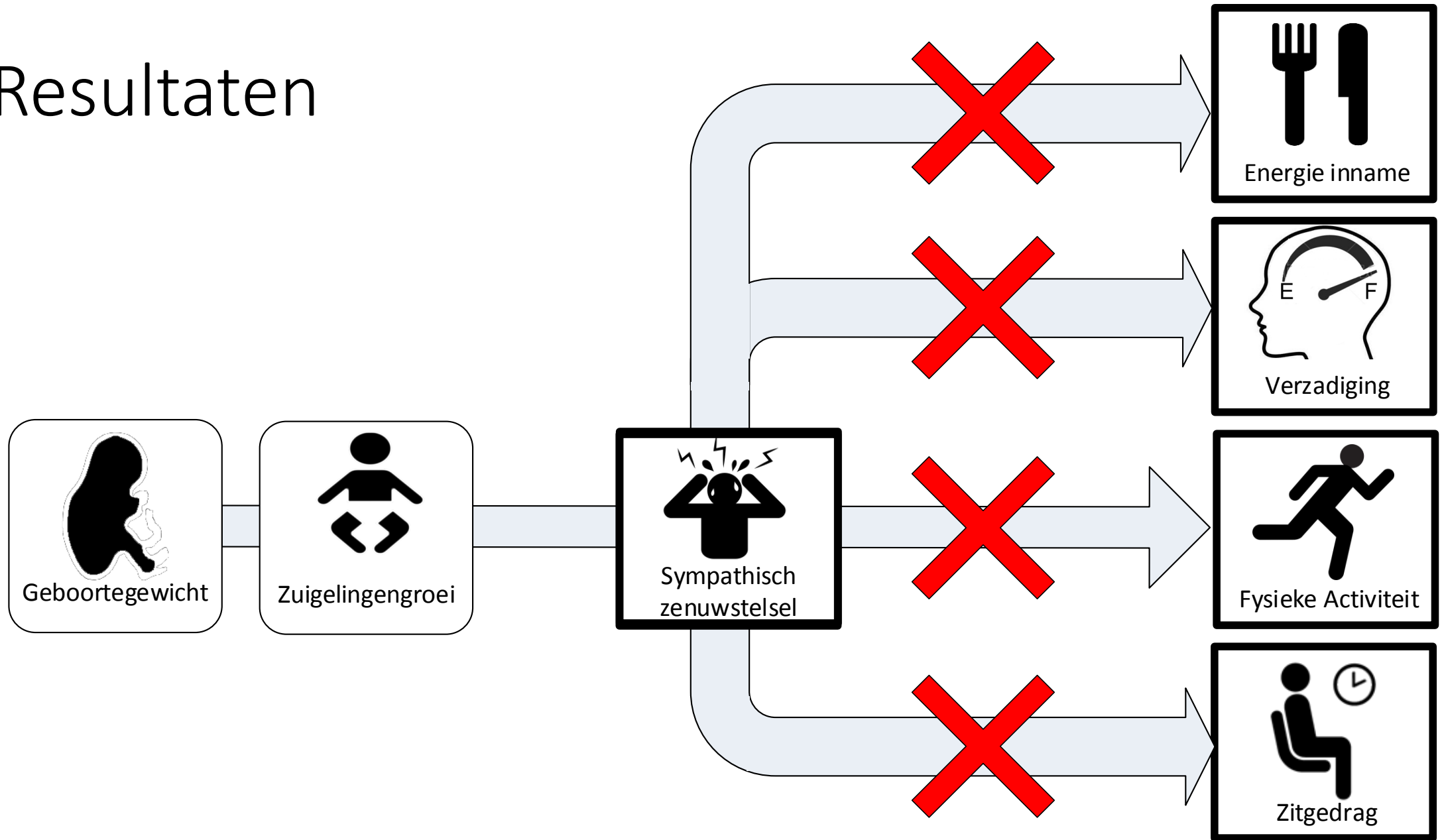

Conclusie

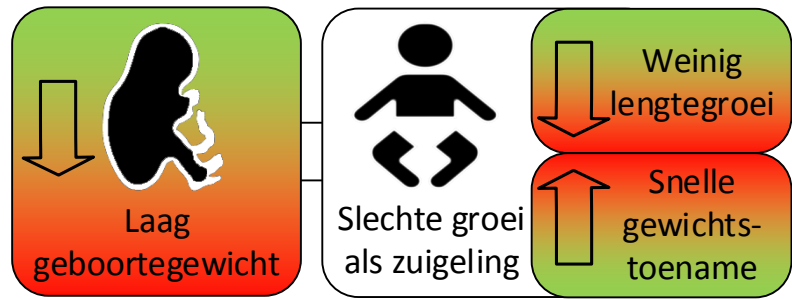

Conclusie

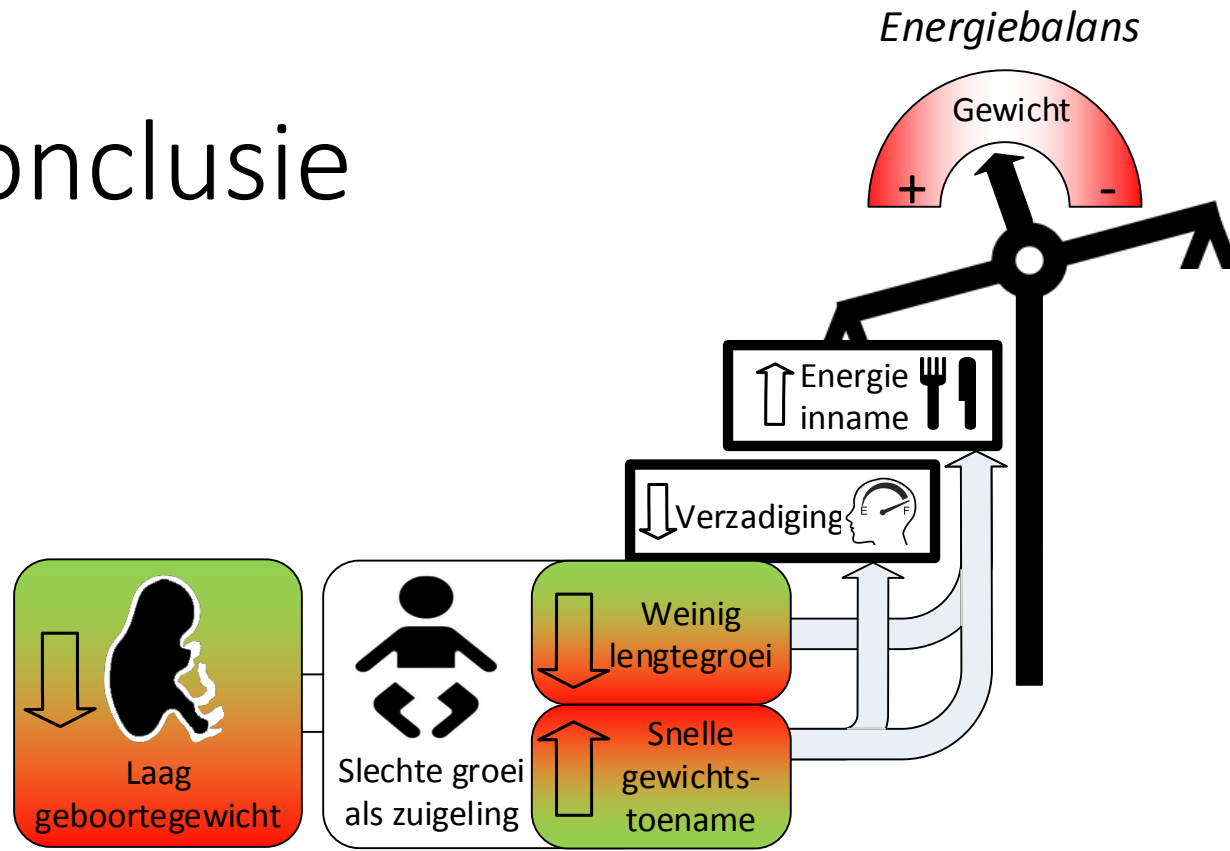

Conclusie

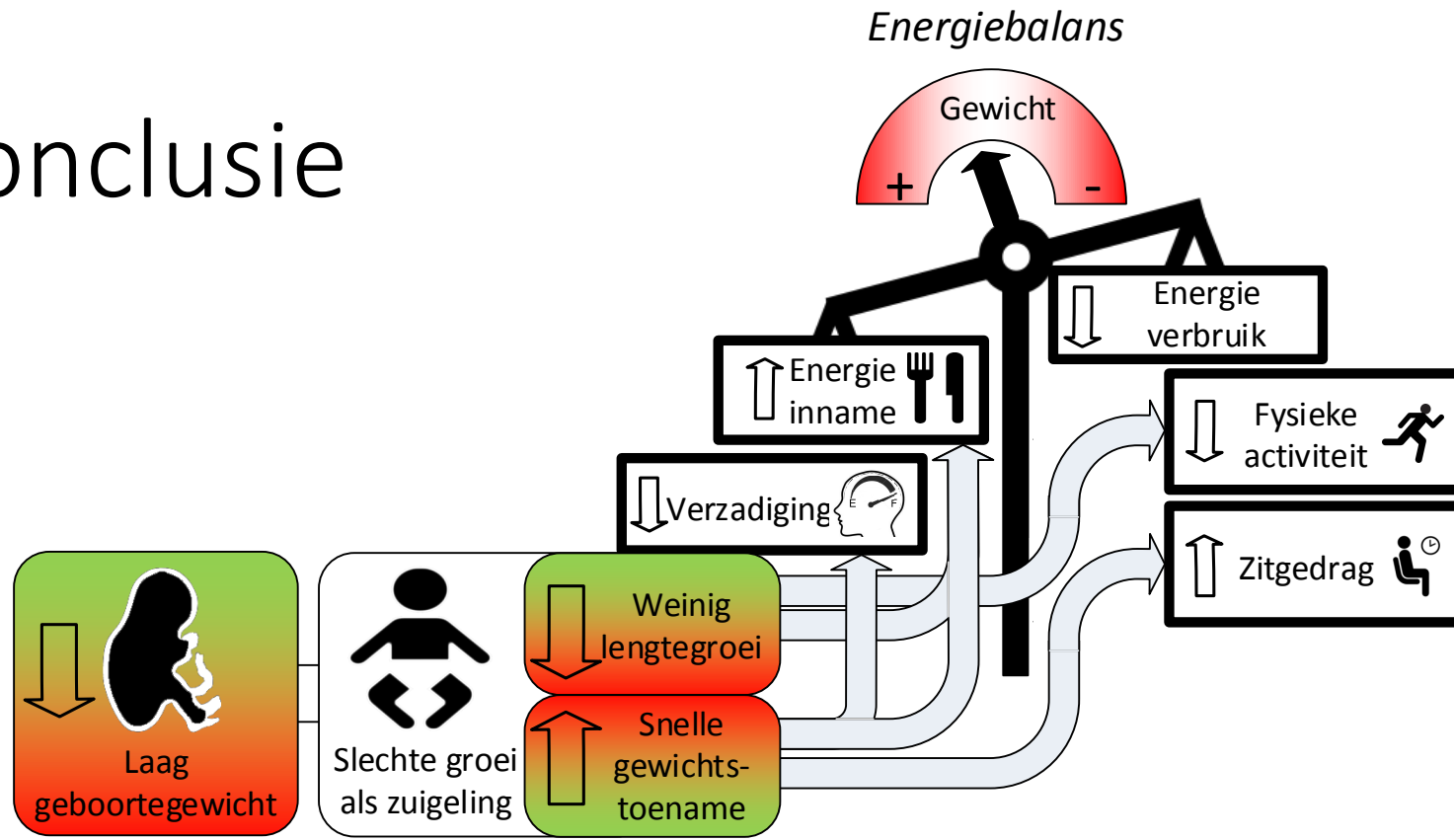

Conclusie

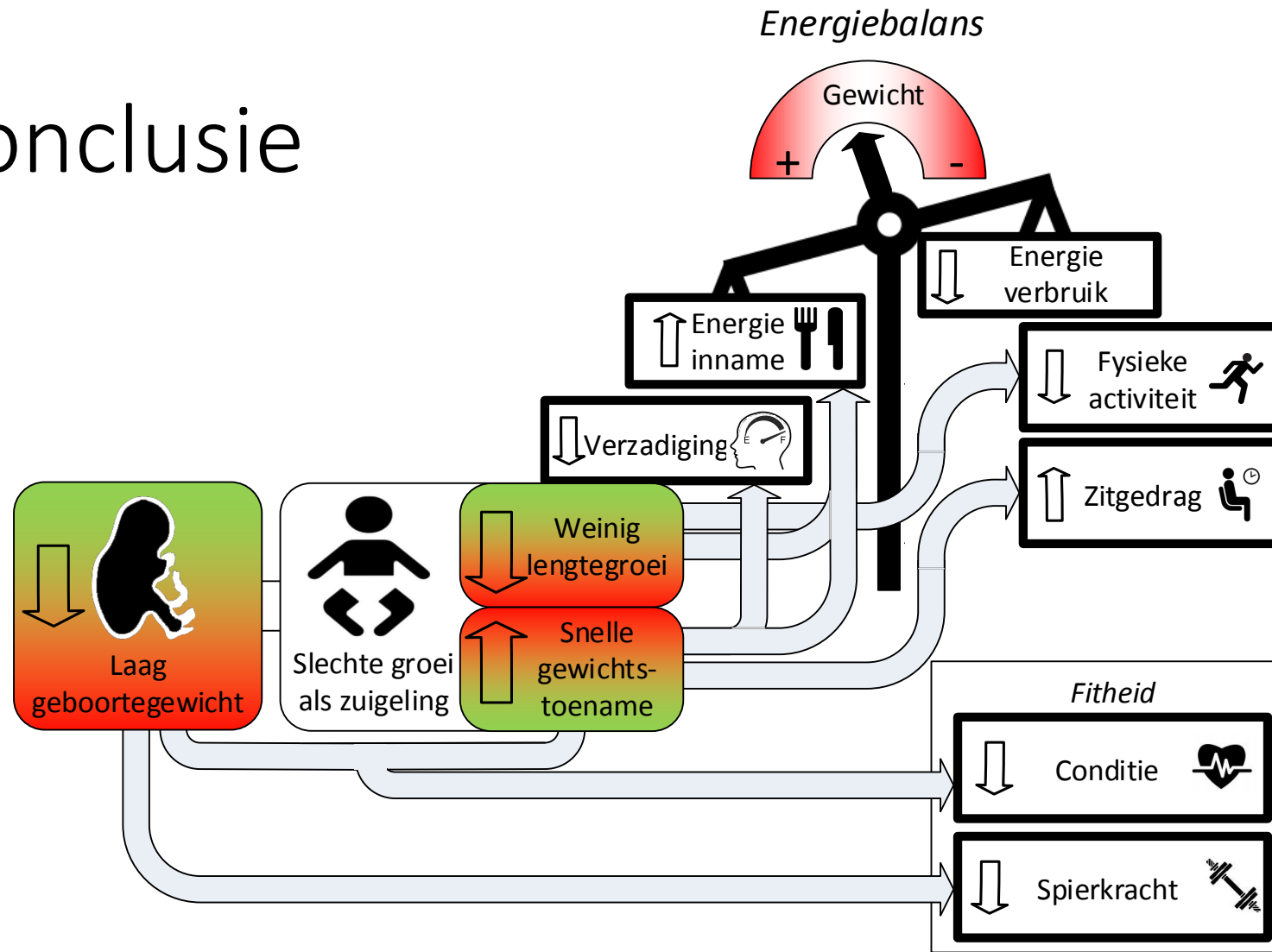

Conclusie

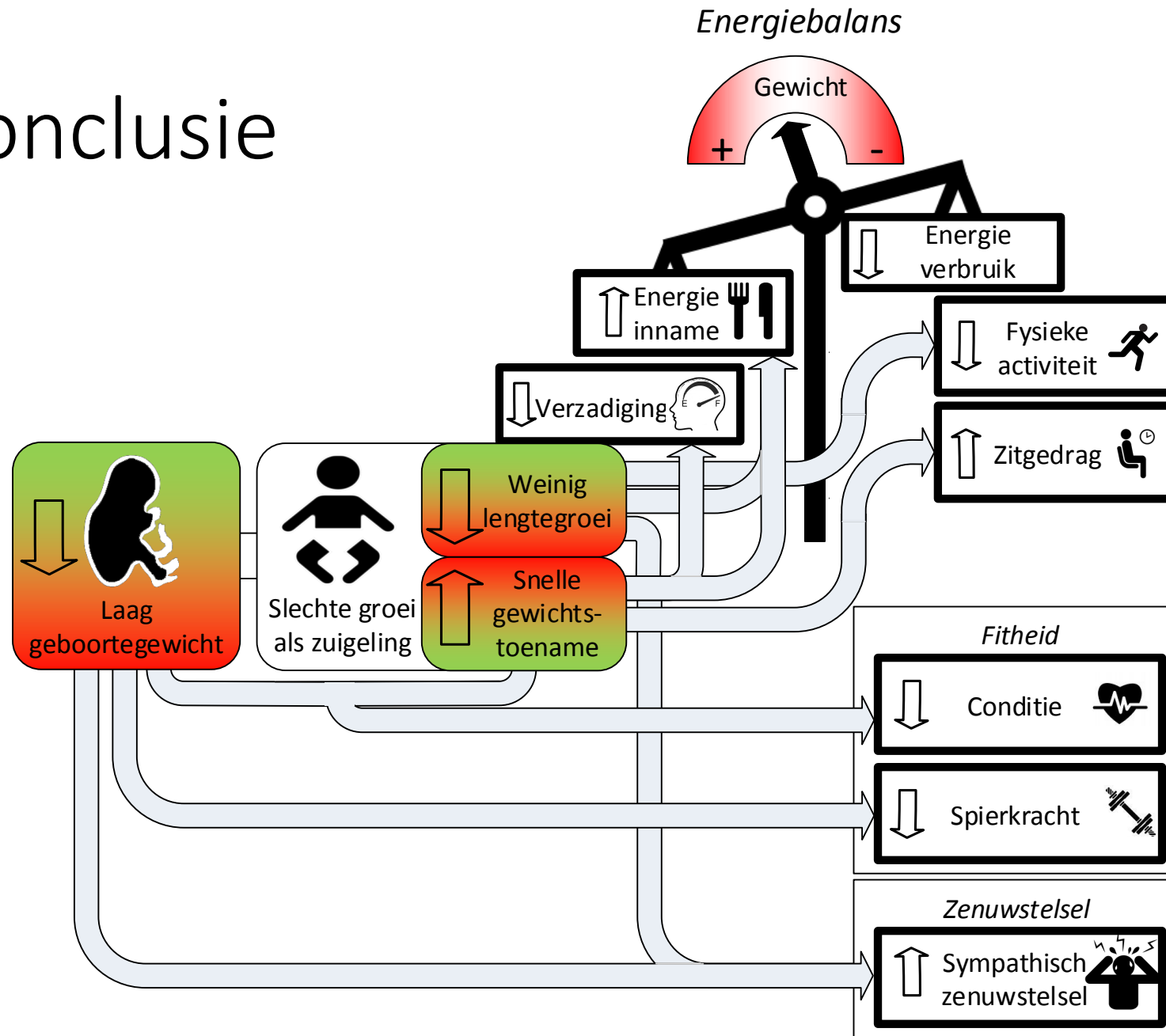

Conclusie

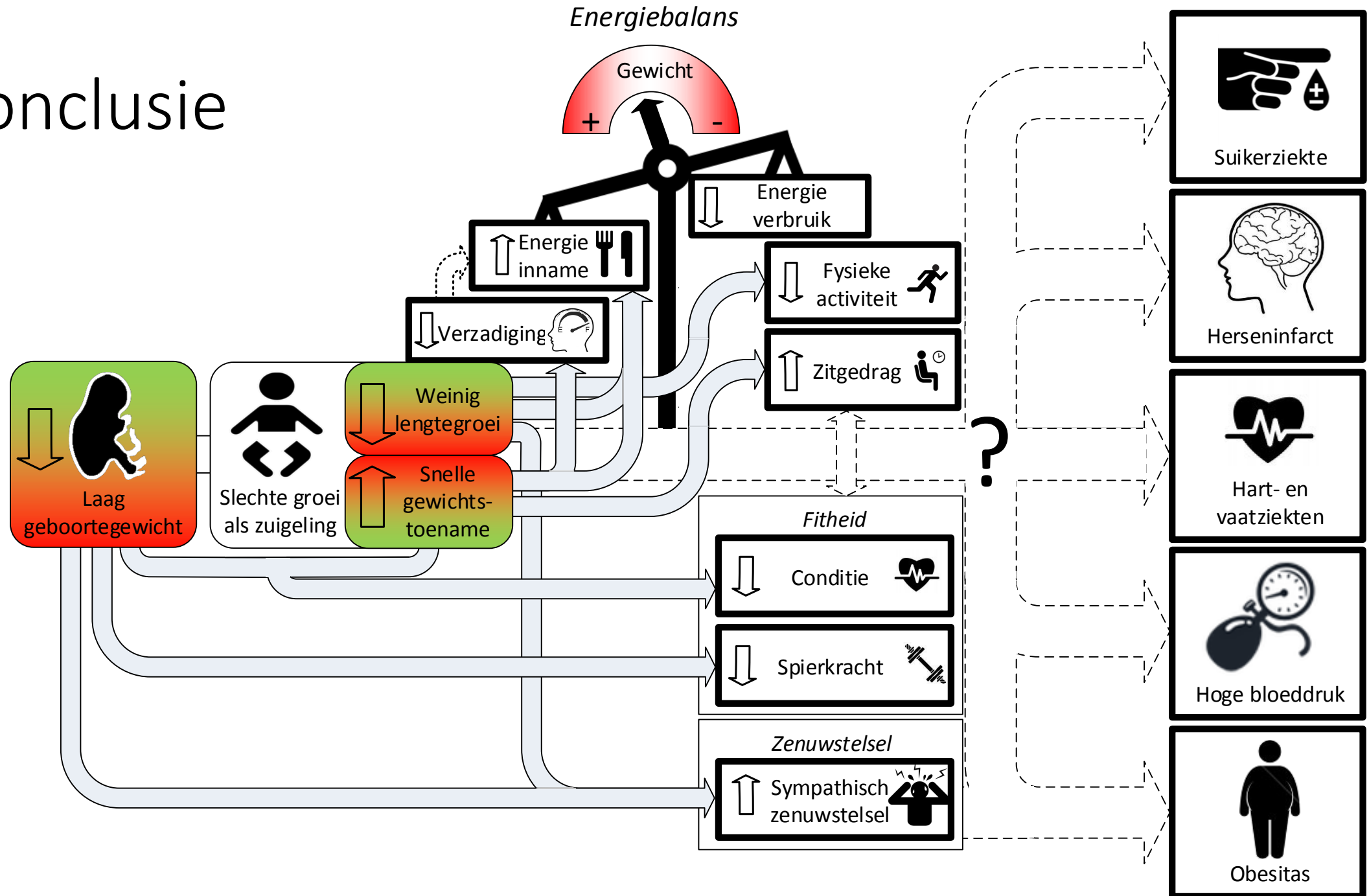

Dank

Begeleiders:

Prof.dr. R.J.B.J. Gemke,
Prof.dr. M.J.M. Chin A Paw,
Dr. T.G. Vrijkotte.

Collega's van de ABCD
studie,

Alle helpers tijdens de
metingen in het
Olympisch Stadion,

Alle kinderen en ouders
van de ABCD studie!

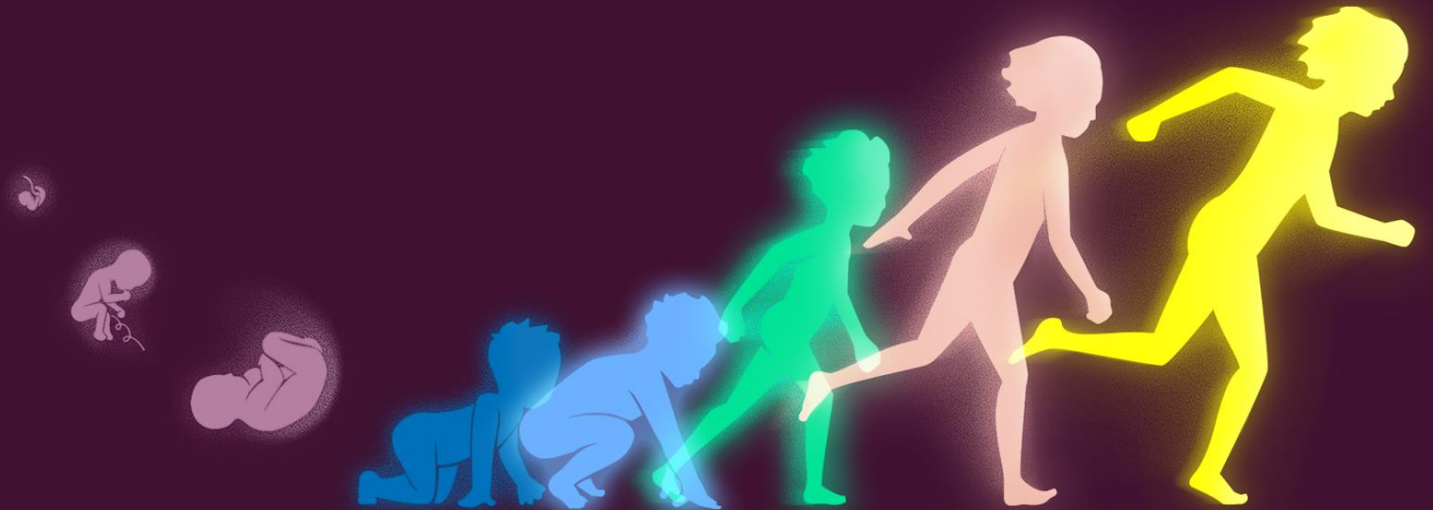

DE OPENBARE VERDEDIGING VAN HET PROEFSCHRIFT

The Developmental Origins of Children's Energy Balance-Related Behavior and Physical Fitness



AREND W. VAN DEUTEKOM

VRIJDAG 21 APRIL 2017